

GPS Receiver Insertion Loss Test and Verification

Model: NTS-150 Tech.: R. Black Pass
 Part #: NTS-150 Date: 4-5-05 Fail

150 Foot Insertion Loss Test – 2x GPS receivers (A&B), 1x Control GPS Receiver (C) not shown
 Control test: GPS Receiver, 150 ft. straight through cable, no Splitter, no Lightning Arrestor.

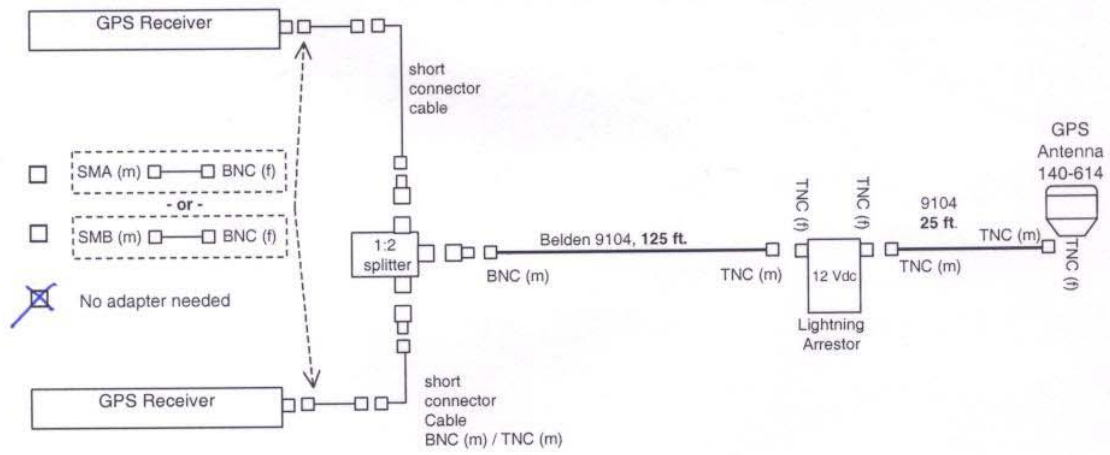

Satellites Locked: A B C Satellites Tracked: A B C Time Accurate: A B C

300 Foot Insertion Loss Test – 2x GPS receivers (A&B), 1x Control GPS Receiver (C) not shown
 Control test: GPS Receiver, 300 ft. straight through cable, Inline Amplifier, no Splitter, no Lightning Arrestor.

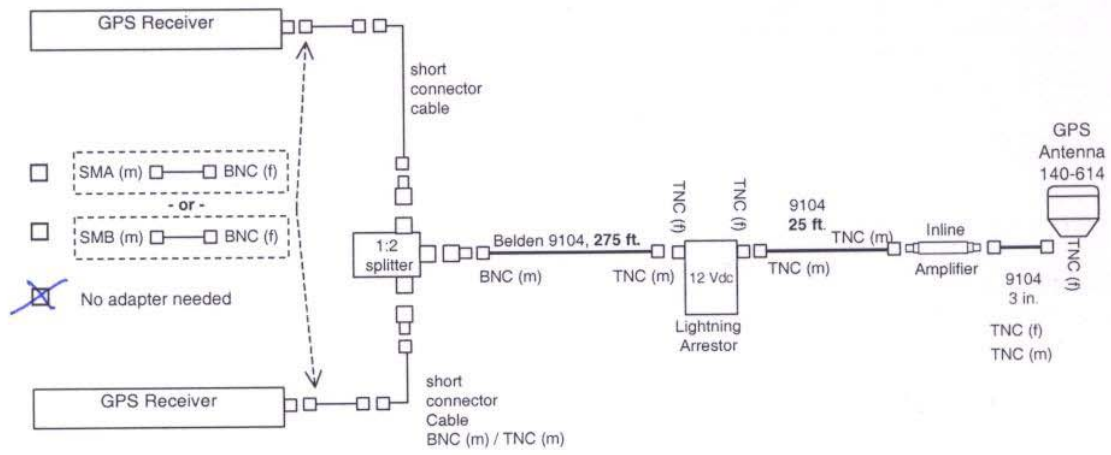

Satellites Locked: A B C Satellites Tracked: A B C Time Accurate: A B C